

Heavy Duty Floor Closers

Absolute Control: Heavy Duty Floor Closers

Floor closers provide the best mechanical means of controlling a door. They are designed to work with the laws of physics to provide long lasting performance and reliability.



Model 25

Screws on standard hinges are attached sideways into the door and frame. As the door starts moving away from the opening, tension is placed on the hinge screws and may ultimately pull them out of the frame and door. A door installed with a floor closer and pivots sits directly on the spindle. The top pivots are attached with screws up into the frame and down into the top of the door. In order for the door to fall out of the frame opening, the screws would have to shear off, which is highly unlikely.

Opening forces and closing forces of floor closers are much more closely correlated than other door control devices. A floor closer opening to 90 degrees with 11 pounds of opening force will have 4 pounds of closing force. A standard surface closer provides an 11 to 6 ratio between opening and closing forces. Therefore, a floor closer is far superior in closing a door, especially when stack pressure or weather conditions are important factors.

Closer Types

- Non Hold-Open (NHO or N)—Closer not equipped with any hold open feature.
- Selective Hold-Open (SHO or S)—Factory-installed on certain series closers. Hold-open may be turned on/off.
- Delayed Action (DA)—Provided on barrier-free installations. Permits door to remain ajar (at 70°) for up to 30 seconds. Operates by separate valve and can be shut off if not needed. Not available on closers furnished with cold weather fluid, and not recommended for exterior applications because of weather factors.
- Physically Handicapped (PH)—Closers which have this feature are preset with 5 pounds of opening force at the factory. Rixson's unique vertical spring allows complete adjustment of spring tension on heavy duty floor closers. Existing installations can be modified to meet new building codes, without replacing the closer. *PH should be ordered for interior doors only.*
- Cold Weather Fluid (CWF)—Should be considered in installations where ground temperature is constantly below +15°F. May be used in temperatures as low as -35°F.

- Sealed Closer (SC)—Used where water contact may occur. Provides gasketing and a cover plate that are epoxied around the case with the closer inside. Not available for replacement closers unless cement case is also replaced.
- Automatic Hold-Open (AHO or A)—Available on certain series closers without deadstop. Preset at factory for specific degree of hold open. Degree of hold-open cannot be changed, nor can closer be made into non-hold-open.

Features

- Floor closers are fully concealed to maintain aesthetic design of the opening.
- Full weight of door is borne by floor closer providing trouble-free operation and long life.
- Doors up to 1,500 pounds are accommodated, allowing standard and heavy doors in a building to be hung by the same means.
- Available offset or center hung to accommodate any installation.
- Vertical adjustment provides for field adjustment of the door if required.
- Specification of heavy panels on the door face with standard offset floor closer preparation available.
- Full floor-to-ceiling concealment is offered for center hung doors providing almost unlimited design flexibility.
- Extended spindles available to accommodate any floor condition.
- Offset models available 3/4" or 1-1/2" offset.
- Offset models available for lead lined doors.
- Offset models available for fire door assemblies up to 3 hours.
- Spring tension and closing speed are field adjustable.
- Built-in fully adjustable hydraulic backcheck standard on 27 and 28 Series.
- Available in all standard architectural finishes—605, 606, 612, 613, 625 and 626.
- Selected floor closers are available with electrical pass through via the spindle.

Handing

To determine the hand of a door for ordering pivots or concealed closers, face the door from the side which swings away from you.

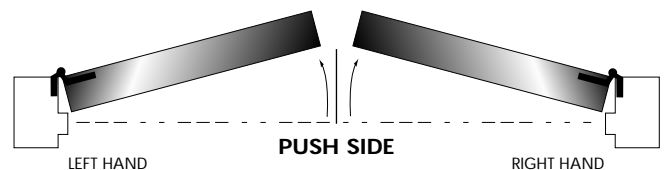

If it opens to the left, it's LH.

If it opens to the right, it's RH.

20 Series
Offset Hung Floor Closers

- All offset hung floor closers are single acting and handed.
- 3/4" offset floor closers locate the pivot point 3/4" from the heel edge of the door and 3/4" from the face of the door.
- 1-1/2" offset floor closers locate the pivot point 3/4" from the heel edge of the door and 1-1/2" from the face of the door.
- Door edges must be beveled 1/8" in 2".
- Frame door stop must be provided at door closed position.
- For door sizes greater than shown, consult us for suggested application.
- Available in all standard architectural finishes.

Model 20
3/4" Offset and
1-1/2" Offset

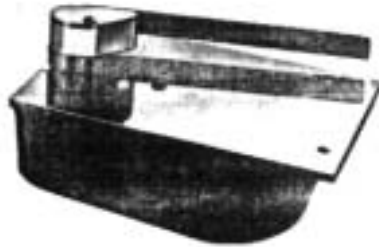

Floor plate installation shown

Features

- Exterior or interior doors weight to 200 lbs.
- Sizes up to 3'6" x 7'0".
- Non-hold open only.
- Cast iron cement case.
- Maximum opening 180° trim permitting.
- Vertical door adjustment.
- Adjustable spring tension and closing speed.
- Built-in hydraulic backcheck cushions opening from 140° to 180°.
- Available for floor plate or threshold installation.
- Standard top pivot: 180 (3/4" offset).
- Recommended intermediate pivot: M19 (3/4" offset).
- ANSI/C06042
- Standard spindle allows up to 3/4" door undercut.
- Standard offset—3/4".

Special offset—1-1/2"

- Door weight to 125 lbs.
- Door sizes up to 3'6" x 7'0".
- Bottom arm—1-1/2" offset.
- Standard top pivot: 180 x 1-1/2".
- Recommended intermediate pivot: M19 x 1-1/2".

Options

- Cold weather fluid available for temperatures below -35°E (specify "CWF").
- Sealed closer available to prevent moisture from entering case—Prefix "SC".
- Extended spindles available in 1/2" increments up to 2".

Specifications

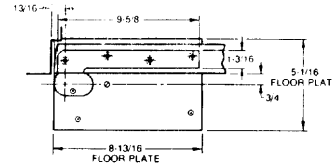

3/4" Offset

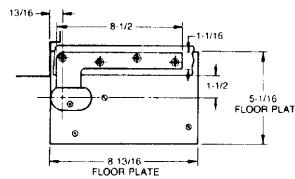
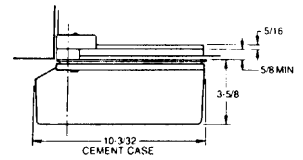

1-1/2" Offset

Ordering Information

Complete 20 Series Closers include:

	3/4" OFFSET	1-1/2" OFFSET	
Top Pivot:	180	180x1-1/2	
Arm Package:	252050	252060	(specify hand)
Floor Plate:	204050	204050	
Closer (less all parts):	20	20	(specify hand)
Cement Case:	203000	203000	

Options available

Heavy Duty Pivot:	H180	H180x1-1/2"
Intermediate Pivot:	M19	M19x1-1/2" (specify hand)

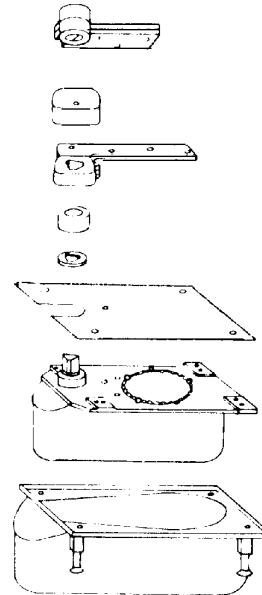

20 Series package includes: closer, cement case, floor plate, arm and shims, arm cap and top pivot.

27 Series Offset Hung Floor Closers

- All offset hung floor closers are single acting and handed.
- 3/4" offset floor closers locate the pivot point 3/4" from the heel edge of the door and 3/4" from the face of the door.
- 1-1/2" offset floor closers locate the pivot point 3/4" from the heel edge of the door and 1-1/2" from the face of the door.
- Door edges must be beveled 1/8" in 2".
- Frame doorstop must be provided at door closed position.
- For door sizes greater than shown, consult us for suggested application.

Model 27 3/4" Offset

- Exterior or interior doors weight to 450 lbs.
- Sizes up to 4'0" x 8'6"

Features

- Available (NHO) non-hold open, (AHO) automatic hold-open or (SHO) selective hold-open at 85, 90, 95 or 105°.
- Cylolac cement case standard.
- Separate independent valves for closing, latch and backcheck adjustments.
- Built-in positive dead stop prevents door from swinging beyond the desired opening degree.
- Vertical door adjustment.
- Adjustable spring tension.
- Standard top pivot: 180—Fire rated: F180.
- Recommended intermediate pivot: M19—Fire rated: FM19.
- ANSI C06041
- Standard spindle allows up to 3/4" door undercut.
- Standard offset 3/4".



Model 27 3/4" Offset



Model 27 1-1/2" Offset

Special Offset—1-1/2"

- Door weight to 200 lbs.
- Door sizes up to 4'0" x 8'6".
- Bottom arm—1-1/2" offset.
- Standard top pivot: 180 x 1-1/2"—Fire rated: F180 x 1-1/2".
- Recommended intermediate pivot: M19 x 1-1/2"—FM19 x 1-1/2".

Options

- Models available to meet ANSIA117.1 requirements for physically handicapped access—prefix "PH".
- Delayed Action option available—prefix "DA".
- Cold weather fluid available for temperatures from 15°F to -35°F (Specify "CWF").

- Sealed closer available to prevent moisture from entering case—Prefix "SC".
- Extended spindles available in 1/2" increments up to 2".
- Available for floor plate or threshold application (floor plate shown).
- For fire rated openings up to 3 hours.
- Prepped for terrazzo pan.

Specifications

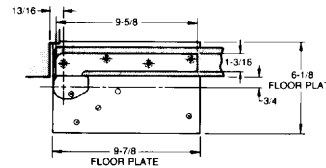

3/4" Offset

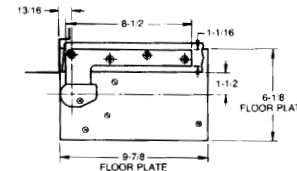
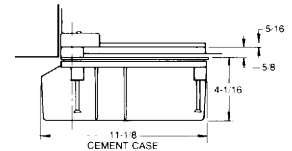

1-1/2" Offset

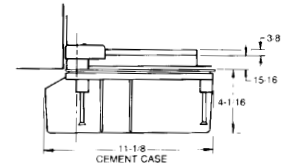

Ordering Information

Complete 27 Series Closers include:

	3/4" OFFSET	1-1/2" OFFSET
Top Pivot:	180	180x1-1/2
Arm Package:	252050	252060 (specify hand)
Floor Plate:	274750	274750 (specify hand)
Closer (less all parts):	27-90N	27-90N (specify hand)
	27-90S	27-90S (specify hand)
	27-105N	27-105N (specify hand)
	27-105S	27-105S (specify hand)
Cement Case:	253000	253000

Options available

Heavy Duty Pivot:	H180	H180x1-1/2
Metal Cement Case:	253001	253001
Intermediate Pivot:	M19	M19x1-1/2 (specify hand)

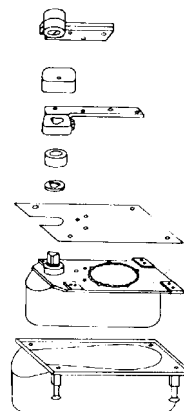

27 Series package includes:
closer, cement case, floor
plate, arm and shims, arm
cap and top pivot.

**27 Series
Offset Hung Floor Closers (Continued)**

- All offset hung floor closers are single acting and handed.
- 3/4" offset floor closers locate the pivot point 3/4" from the heel edge of the door and 3/4" from the face of the door.
- Door edges must be beveled 1/8" in 2".
- Frame doorstop must be provided at door closed position.
- For door sizes greater than shown, consult us for suggested application.

**Model L27
3/4" Offset**



- Lead lined doors.
- Weight up to 1500 lbs.
- Sizes up to 4'0" x 8'6".

Features

Identical to Model 27 except:

- Cast iron cement case standard.
- Designed for leadlined doors with lead in center of door (consult us when lead shielding is immediately behind face panel of door).
- Bottom arm features anti-friction bearing for greater load capacity.
- Screw holes in top pivot and bottom arm straddle lead lining.
- Available to accommodate door thicknesses 1-3/4", 2", 2-1/4", 2-1/2", or 3".
- Standard top pivot: L180—Fire rated: FL180.
- Recommended intermediate pivot: ML19—Fire rated: FML19.
- ANSI/C06071
- 3/4" offset only.

Options

- Cold weather fluid available for temperatures below -35°F (specify "CWF").
- Sealed closer available to prevent moisture from entering case—Prefix "SC".
- Extended spindles available in 1/2" increments up to 2".
- For fire rated openings up to 3 hours (non-hold open only).
- Available for floor plate or threshold installation.

L27 closers are available with Special Layout #438 as an option. See the Special Layouts section for more details.

Specifications

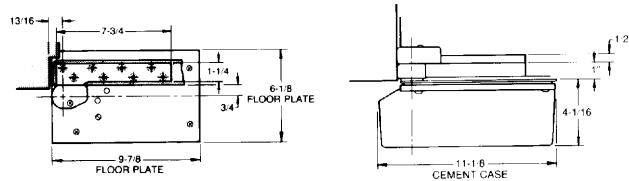

Ordering Information

Complete L27 Series Closers include:

- Top Pivot: L180
- Arm Package: 252051 (specify hand)
- Thrust Bearing: 41204-PKG
- Floor Plate: 274750 (specify hand)
- Closer (less all parts): L27-90N (specify hand)
- L27-90S (specify hand)
- L27-105N (specify hand)
- L27-105S (specify hand)
- Cement Case: 253001

Options available

- Intermediate Pivot: ML19 (specify hand)

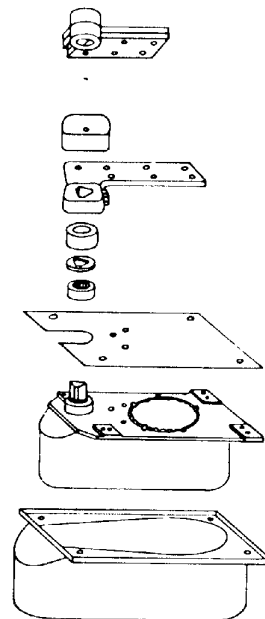

L27 Series package includes: closer, cement case, floor plate, arm and shims, thrust bearing, arm cap and L180 top pivot.

Heavy Duty Floor Closers

**27 Series
Offset Hung Floor Closers (Continued)**

- All offset hung floor closers are single acting and handed.
- 3/4" offset floor closers locate the pivot point 3/4" from the heel edge of the door and 3/4" from the face of the door.
- Door edges must be beveled 1/8" in 2".
- Frame doorstop must be provided at door closed position.
- For door sizes greater than shown, consult us for suggested application.

**Model Q27
3/4" Offset**

- Exterior or Interior Doors.
- Weight to 350 lbs.
- Door width up to 4'0".



Features

Identical to Model 27 except:

- Standard top pivot: 180—Fire rated: F180.
- One M19 intermediate pivot included in closer package. An additional M19 pivot required for doors over 195 lbs. and/or door over 90". Intermediate pivot required for closer removal without door removal. For fire rated openings, use FM19 intermediate pivot.
- Arm is surface mounted with thru bolts which allows door to remain active when closer is removed for repair.
- Minimum 85° door swing.
- Floor plate installation.
- Door must be 1-3/4" thick and installed with 3/4" offset pivots.
- 3/4" offset only (measured from center line of pivot to face of door).
- ANSI/C06041—Fire rated: ANSI/C06051.

Options

- Delayed Action option available—prefix "DA".
- Cold weather fluid available for temperatures from 15°F to -35°F (Specify "CWF") Not available with "DA".
- Extended spindles available in 1/2" increments up to 2".
- Models available to meet ANSI A117.1 requirements for physically handicapped access—prefix "PH".
- For fire rated openings up to 3 hours (non-hold open only).
- Sealed closer available to prevent moisture from entering case—Prefix "SC".

Specifications

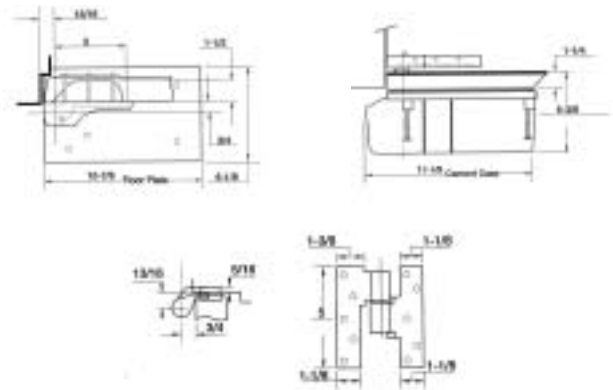

Ordering Information

Complete Q27 Series closers include:

- Top Pivot: 180
- Intermediate Pivot: M19 (specify hand)
- Arm Package: 222050 (specify hand)
- Floor Plate: 294750 (specify hand)
- Filler Block: 73009 2 Required!
- Closer (less all parts): Q27-90N (specify hand)
- Q27-90S (specify hand)
- Cement Case: 253000

Options include:

- Heavy Duty Top Pivot: H180
- Metal Cement Case: 253001
- Heavy Duty Intermediate Pivot: M190 (specify hand)

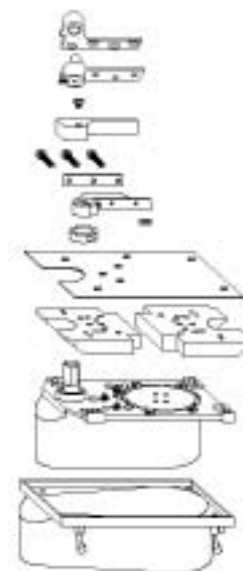

Q 27 Series package includes: closer, cement case, plate, arm and shims, arm cap, Q27 filler block, intermediate pivot and 180 top pivot.

27 Series
Offset Hung Floor Closers (continued)

- All offset hung floor closers are single acting and handed.
- 3/4" offset floor closers locate the pivot point 3/4" from the heel edge of the door and 3/4" from the face of the door.
- Door edges must be beveled 1/8" in 2".
- Frame doorstop must be provided at door closed position.
- For door sizes greater than shown, consult us for suggested application.

Model HM27
3/4" Offset

- Exterior or interior doors.
- Hollow metal doors and frames.
- Weight up to 250 lbs.
- Door width to 4'0".



Floor plate installation shown

Features

Identical to Model 27 except:

- Designed for stock metal doors and frames with 4.5" x 4.5" preparation.
- Complete installation includes three ball bearing bronze 3/4" offset hinges. For Fire rated openings, steel hinges are required.
- Arm is surface mounted with thru-bolts and allows closer to be removed without removing door.
- 3/4" offset only (measured from center line of pivot to face of door).
- For 1-3/4" doors only.
- ANSI/C06041—Fire rated: ANSI/C06051.

Options

- Delayed Action option available—prefix "DA".
- Cold weather fluid available for temperatures from 15°F to -35°F. (Specify "CWF") Not available with "DA".
- Extended spindles available in 1/2" increments up to 2".
- Models available to meet ANSI A117.1 requirements for physically handicapped access—prefix "PH".
- For fire rated openings up to 3 hours (non-hold open only).
- Sealed closer available to prevent moisture from entering case—Prefix "SC".

Specifications

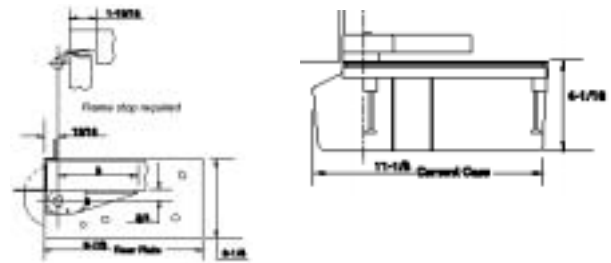

Ordering Instructions

Complete HM27 Series closers include:

Hinge:	254545-PK	3 Required
Arm Package:	222050-HM	(specify hand)
Floor Plate:	274750	(specify hand)
Closer (less all parts):	27-90N	(specify hand)
	27-90S	(specify hand)
Cement Case:	253000	

Options include:

Metal Cement Case:	253001
--------------------	--------

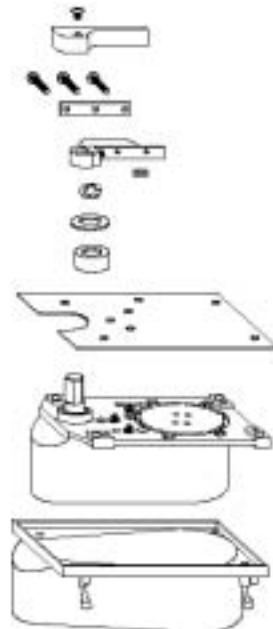

HM 27 Series package includes: closer; cement case, plate, arm and shims, arm cap and three bronze 4.5 x 4.5" 3/4" offset hinges.

Heavy Duty Floor Closers

**27 Series
Offset Hung Floor Closers (continued)**

- All offset hung floor closers are single acting and handed.
- 3/4" offset floor closers locate the pivot point 3/4" from the heel edge of the door and 3/4" from the face of the door.
- Door edges must be beveled 1/8" in 2".
- Frame doorstop must be provided at door closed position.
- For door sizes greater than shown, consult us for suggested application.

**Model 127
3/4" Offset**

- Exterior or Interior Doors
- Deep reveal applications
- Weight to 250 lbs.
- Door width up to 4'0"



Features

Identical to Model 27 except:

- Recommended for openings where vertical movement of the door at installation is a problem.
- Standard top pivot: 180—Fire rated: F180.
- Intermediate pivot required: 119 - Fire rated: FM19 (order separately).
- 3/4" offset only.
- ANSI/C06041

Options

- Delayed action option available—prefix "DA"
- Cold weather fluid available for temperatures from 15°F to -35°F (Specify "CWF") Not available with "DA".
- Extended spindles available in 1/2" increments up to 2".
- Models available to meet ANSI A117.1 requirements for physically handicapped access—prefix "PH".
- For fire rated openings up to 3 hours (non-hold open only).
- Sealed closer available to prevent moisture from entering case—Prefix "SC".

Specifications

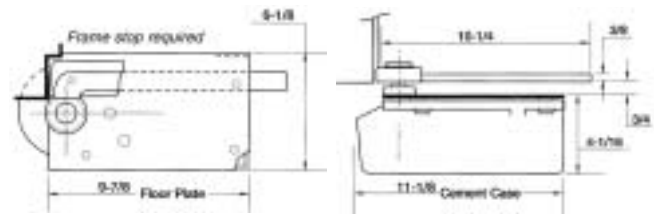

Ordering Instructions

Complete 127 Series closers include:

Top Pivot:	180	
Arm Package:	652050	(specify hand)
Floor Plate:	274750	(specify hand)
Closer (less all parts):	127-90N	(specify hand)
	127-90S	(specify hand)
Cement Case:	253000	

Options include:

Heavy Duty Top Pivot:	H180	
Metal Cement Case:	253001	
Intermediate Pivot:	M19	(specify hand)

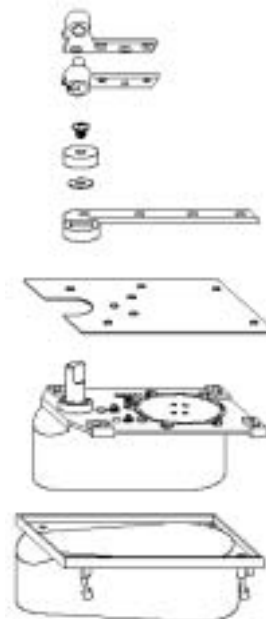

127 Series package includes: closer; cement case, plate, arm, arm cap and top pivot.

27 Series
Offset Hung Floor Closers (Continued)

- All offset hung floor closers are single acting and handed.
- 3/4" offset floor closers locate the pivot point 3/4" from the heel edge of the door and 3/4" from the face of the door.
- Door edges must be beveled 1/8" in 2".
- Frame doorstop must be provided at door closed position.
- For door sizes greater than shown, consult us for suggested application.

Model 327
3/4" Offset



- Interior doors.
- Door width up to 4'0".

Features

Identical to Model 27 except:

- Used in butt hinge and pocket pivot applications.
- Door hanging means supplied by others.
- Deadstop at 90 degrees.
- Not available with DA, PH or HO options.
- ANSI/C06031

Options

- Cold weather fluid available for temperatures from 15°F to -35°F (Specify "CWF").
- Extended spindles available in 1/2" increments up to 2".
- Sealed closer available to prevent moisture from entering case—Prefix "SC".

Specifications

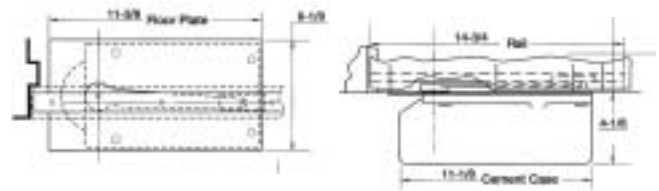

Ordering Instructions

Complete 327 Series closers include:

- Arm Package: 3252010 (specify hand)
- Floor Plate: 3274010 (specify hand)
- Closer (less all parts): 327-90N (specify hand)
- Cement Case: 253000

Options include:

- Metal Cement Case: 253001

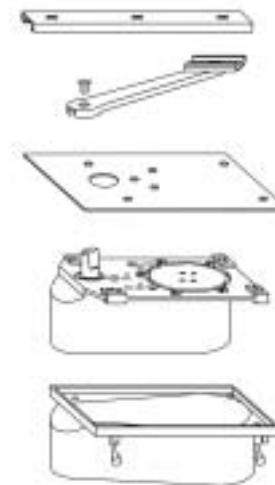

327 Series package includes: closer, cement case, plate and arm package.